

**VSX-LX805**  
AV RECEIVER / RECEPTEUR AV

**Initial Setup Guide**

Guide de Configuration Initiale / Guía de configuración inicial /  
初始設置指南 (初始设置指南)



SN 29403961 O2301-0

"Pioneer" and "ELITE" are trademarks of Pioneer Corporation, and are used under license.

**1**

**MANUAL**

**En** This document uses a 7.1 channel system as an example when describing use. Refer to the online instruction manual when using other than a 7.1 channel system.

**Fr** Ce document utilise le système 7.1 comme exemple pour décrire l'utilisation. Consultez le mode d'emploi en ligne pour utiliser autre chose qu'un système 7.1.

**Es** Este documento utiliza un sistema de 7.1 canales como ejemplo para describir el uso. Consulte el manual de instrucciones online cuando utilice un sistema distinto al de 7.1 canales.

**Tw** 本文在說明使用時以 7.1 聲道系統為例。若使用 7.1 聲道以外的其他系統，請參閱線上說明手冊。

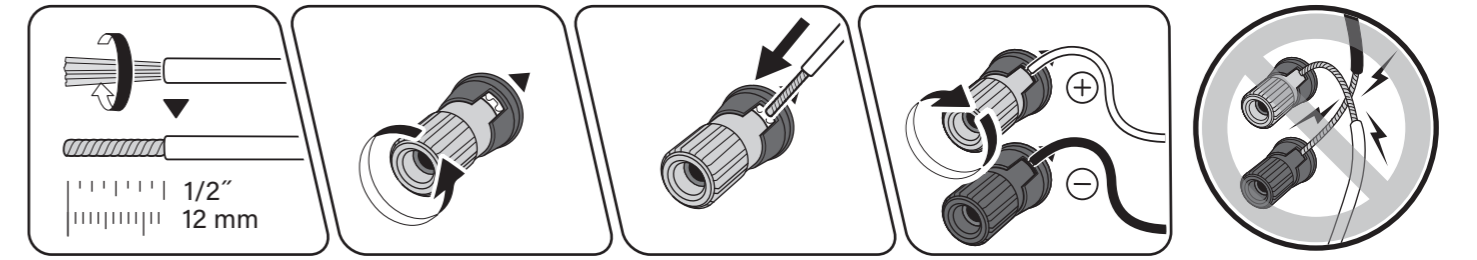
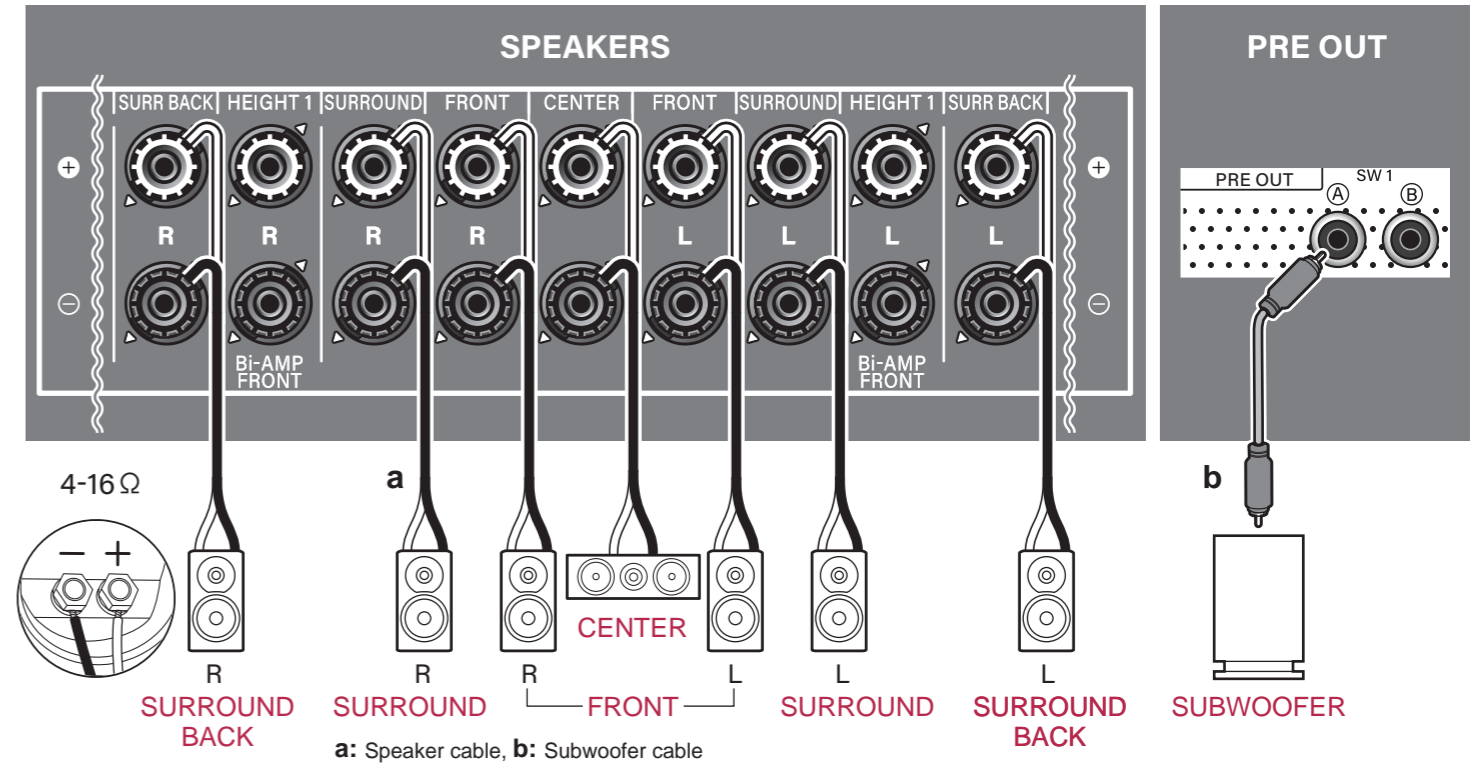
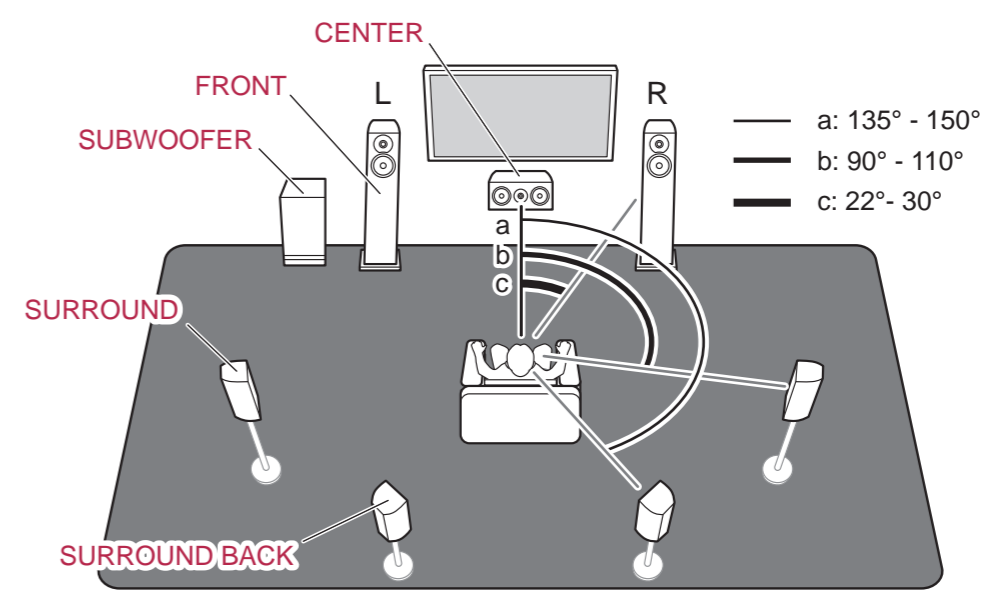
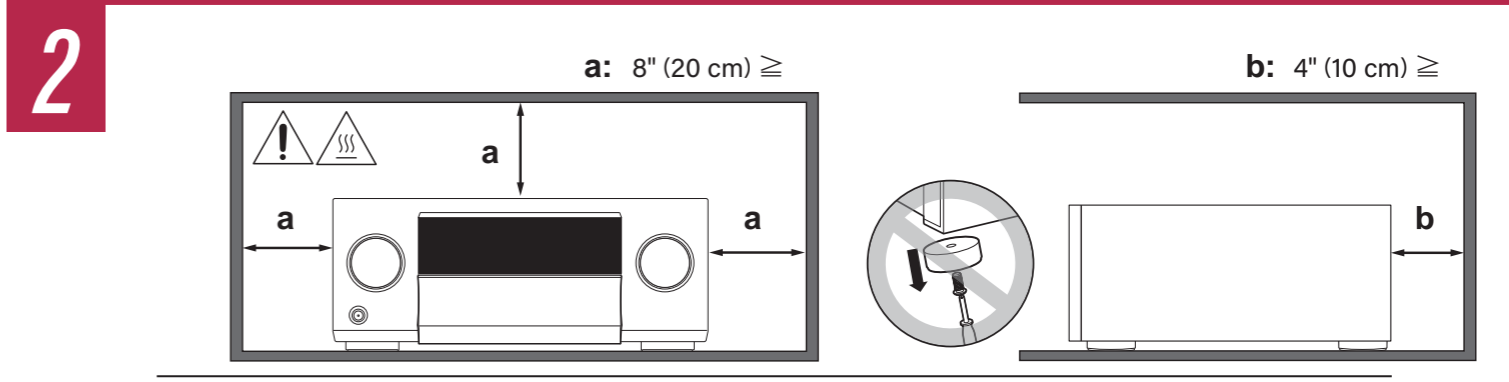

3

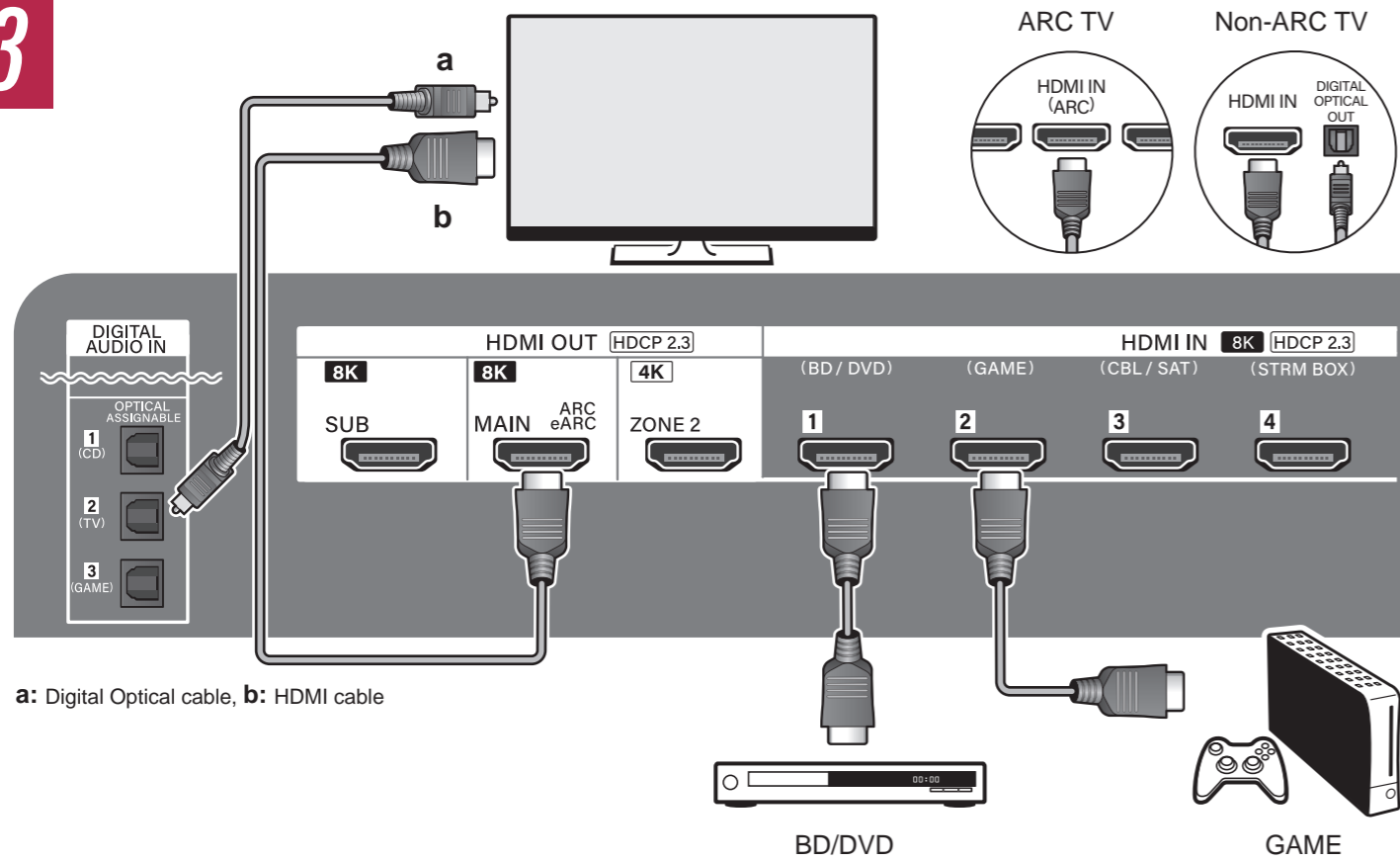

a: Digital Optical cable, b: HDMI cable

**En** Be sure to insert the HDMI cable all the way in. / **Fr** Assurez-vous d'avoir inséré le câble HDMI à fond. / **Es** Asegúrese de insertar el cable HDMI del todo. / **Tw** 確保將 HDMI 電纜完全插入。

Wi-Fi / Bluetooth®

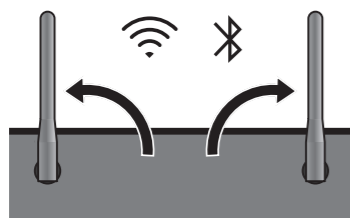

NETWORK

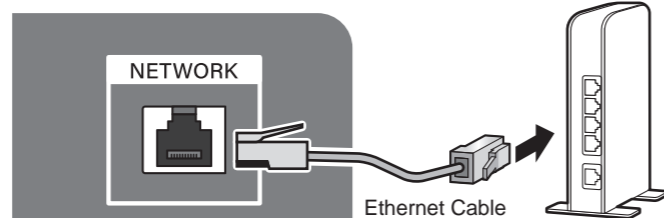

ANTENNA

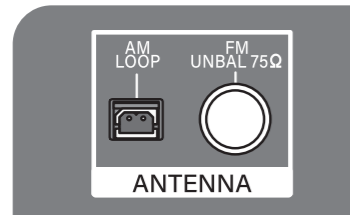

AM

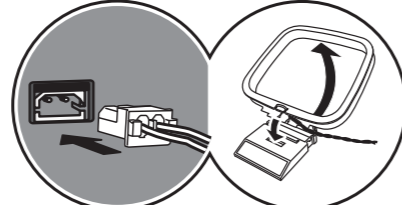

FM

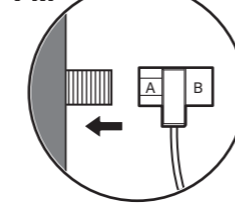

4

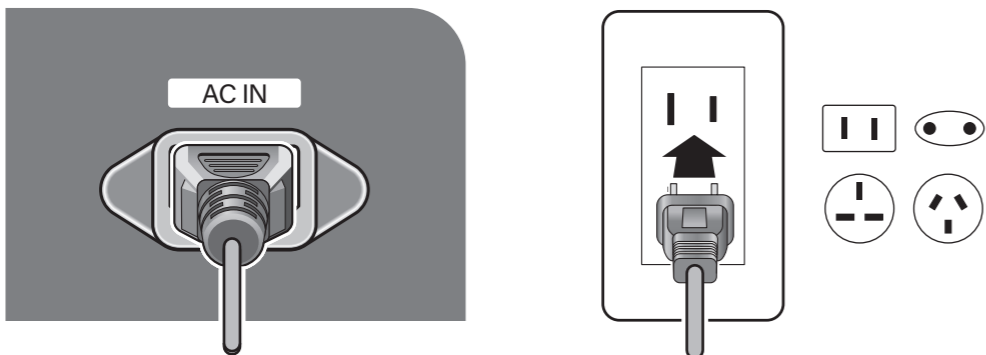

5

**En** Follow the guidance displayed on the screen to complete Initial Setup. / **Fr** Suivez les instructions affichées sur l'écran pour terminer la Configuration initiale. / **Es** Siga la guía mostrada en la pantalla para completar la configuración inicial. / **Tw** 按照螢幕上顯示的指引完成初始設定。

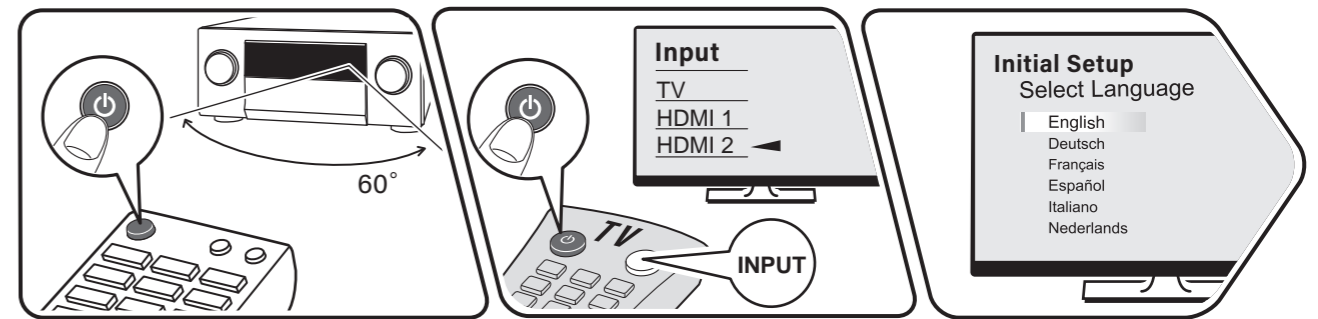

**En** To redo the initial setup / **Fr** Pour refaire la configuration initiale / **Es** Para rehacer la configuración inicial / **Tw** 重新執行初始設置  
 Home > System Setup > Miscellaneous > Initial Setup

6

**En** Playing audio and video / **Fr** Lecture du son et de la vidéo / **Es** Reproducción de audio y vídeo / **Tw** 播放音訊與視訊

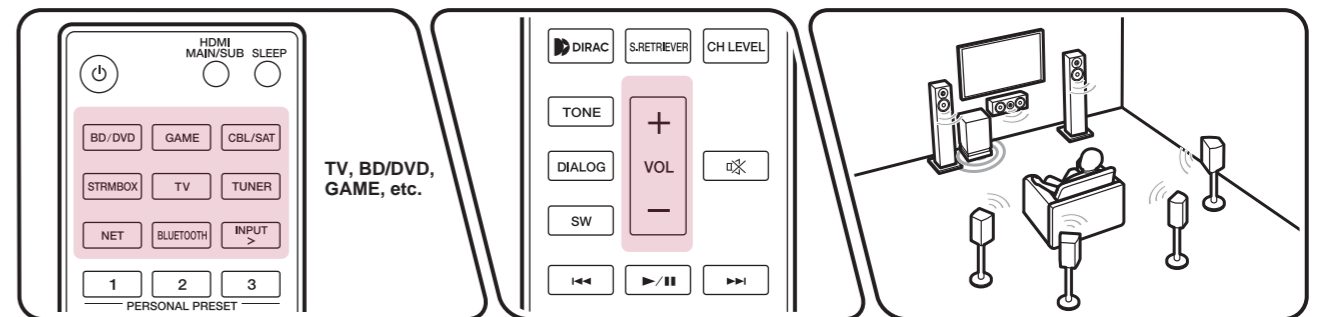

Troubleshooting

Dépannage / Solución de problemas / 故障檢修

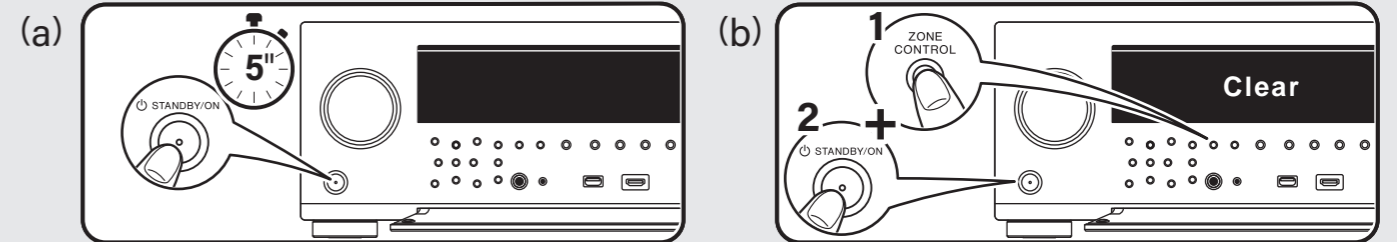

**En** Try restarting the unit. Switch this unit to standby, then do (a). If the problem is not fixed, try the following: Unplugging the power cord and HDMI cables then replugging them in again / Initializing the settings (do (b) while this unit is ON) / Updating the firmware

**Fr** Essayez de redémarrer l'appareil. Passez l'appareil en veille, puis effectuez (a). Si le problème n'est pas résolu, essayez les choses suivantes : Débrancher le cordon d'alimentation et les câbles HDMI puis les rebrancher / Initialiser les réglages (effectuer (b) pendant que cet appareil est sur ON) / Mettre à jour le micrologiciel

**Es** Pruebe a reiniciar la unidad. Ponga esta unidad en espera y luego haga (a). Si el problema no se soluciona, intente lo siguiente: Desenchufar el cable de alimentación y los cables HDMI y luego volver a enchufarlos / nicializar los ajustes (haga (b) mientras esta unidad está ON) / Actualizar el firmware

**Tw** 嘗試重新啟動本機。將本機切換為待機，然後執行 (a)。如果仍無法解決問題，請嘗試下列動作：拔下電源線及 HDMI 電纜，然後重新插上 / 初始化設定 (在本機 ON 時執行 (b)) / 更新韌體

Voice Control Guide

<https://jp.pioneer-audiovisual.com/manual/playback/vcg.pdf>



ChromeCast Built-in

<https://jp.pioneer-audiovisual.com/manual/playback/chromecast.pdf>

